

Part-load characteristics of Organic-Rankine-Cycles

Tobias Erhart^(1,2), Ursula Eicker⁽¹⁾, David Infield⁽²⁾

(1) University of Applied Sciences Stuttgart, zafh.net, Germany

(2) University of Strathclyde Glasgow, Dept. of Electronical and Electrical Engineering, UK

(1) Schellingstrasse 24, 70174 Stuttgart, Germany

(2) 204 George Street, G1 1XW Glasgow, Scotland

Abstract

This paper shows analytic results of the operation of a heat guided biomass combined heat and power (CHP) plant using Organic-Rankine-Cycle (ORC) technology and a district heating system as a heat sink.

Dependencies and constraints in the annual operation of the plant are shown as well as the detailed effects of various parameters.

Keywords

Power plant, Biomass, Renewable Energy, District heating, Combined heat and power (CHP), Organic-Rankine-Cycle (ORC), poly-generation, part-load

Introduction

Facing the challenges for a de-centralised and highly efficient power supply, more than 150 ORC-plants have been installed all over Central Europe. The majority of modules have been produced by the market leader Turboden of Italy. The vast majority (140) is based on biomass combustion systems. More than 50 of those biomass cogeneration plants feed their sink heat into district heating systems [10]/[11].

The POLYCITY project is examining the ORC-technology within the project site of “Scharnhäuser Park” a quarter of the city of Ostfildern, near Stuttgart. Having been taken into operation in the year 2003 the plant supplies the heat demand of a growing quarter with an actual population of 6,500 (summer of 2010 [13]). The power plant was designed for a maximum annual heat production of 35000 MWh. The 8 MW_{th} biomass furnace burns wood chips and landscape preservation material with widely varying qualities.

Via the thermal oil system the combustion heat is transferred from the main building to the turbine house where it feeds the ORC module (feed: ~300°C, return: ~240°C). The module (M-1000), constructed by the German company GET and modified by GMK, has a design electric output of approximately 1 MW_{el} (950 kW). The thermal input is 6356 kW_{th}.

Manufacturers advertise the Organic-Rankine-cycle having a good and stable partial load behaviour over a wide range, compared to other technologies, such as steam cycle. Obernberger [2] has shown that with an ORC module produced by the company of Turboden. The analyses results show that there are several dependencies that influence the electric cycle efficiency in a negative way.

Methods

Data measured during the period of operation (2004-2010) of the thermal oil cycle, the ORC and the district heating will be presented and assessed. For the detailed analysis of the OR-Cycle data from 2010 measured in the cycle leading to a detailed insight into the thermodynamic processes. Expected turbine and heat exchanger behaviour will be compared to measured values. As the chart in Figure 1 shows, there have been larger periods of revision. In 2005 and 2006 the electricity production was off the grid due to a leakage in the evaporator. After the replacement the ORC-module has been running for two years rather successfully. In November 2008 a fire caused severe damage in the main building. This caused a non-biomass based operation for almost one year. In the 2007 to 2008 winter period a fully consistent set of data could be acquired.

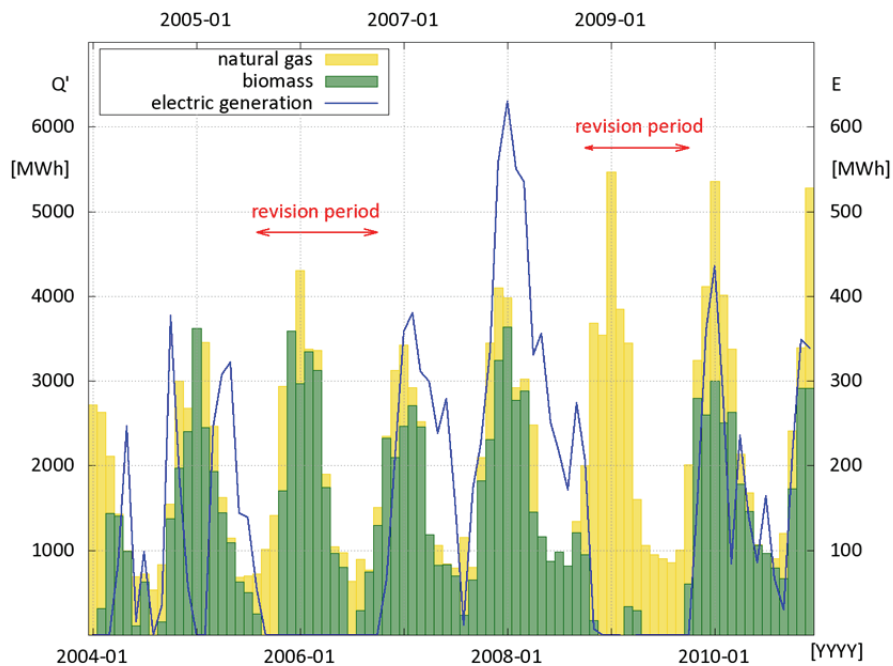

Figure 1: monthly heating energy produced from biomass and natural gas and ORC electric yield

The main aggregates responsible for the load behaviour of the cycle have been examined in detail. The evaporator serves as a source, the condenser as a sink and the turbine as the expander.

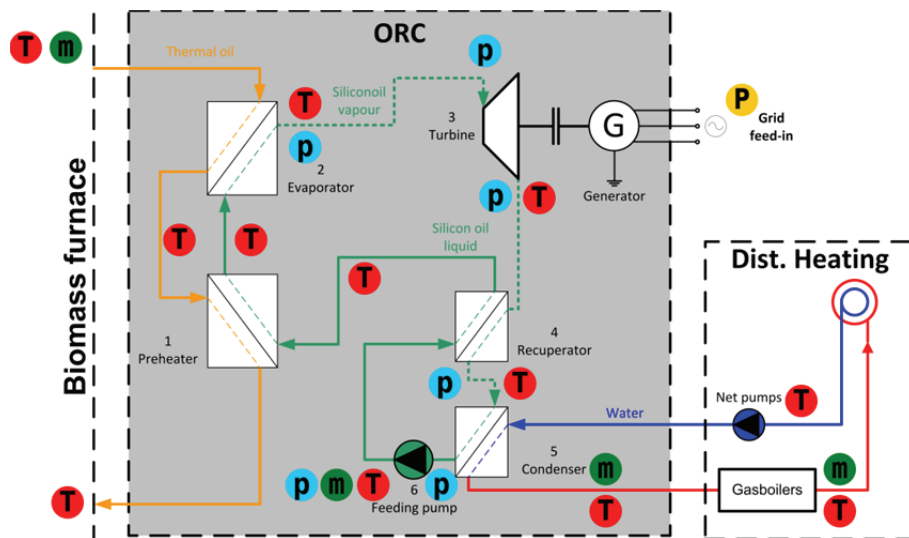

Figure 2: Scheme of the of the OR-Cycle including sensors and gauges [ERHART]

Figure 2 shows a simplified scheme of the cycle together with the monitoring system. The start-up cycle and the vacuum system are not displayed here. The gearbox and the excess cooling are neglected as well. The thermal oil heat input is measured via Kamstrup heat meters [14]/[15]. The caption dots p, T and m represent pressure, temperature and mass flow sensors. Values from these sensors are processed by the control system of the cycle via profi-bus. In November 2009 a profi-bus to TCP/IP interface has been installed. Via the OPC protocol the values can be displayed by the OPC-server and recorded by an OPC-client. For this purpose an OPC-client, based on the Softing [18] architecture has been developed. For the analyses hereinafter all sensors and relevant control parameters have been monitored with a time step of 10 seconds in datasets of 24 hours. The data are written to CSV-files from where they can be further processed.

To derive the load characteristics of this cycle, data from the power plant and the ORC are unified. Based on the minute values empirical models have been calculated to clarify the influence of various parameters to the entire system.

Results

Empirical approach – entire cycle

To show the dependencies of the electric output to various input variables a genetic algorithm analysis [17] has been used. To train the model minute values from 2008 have been taken. These results implied a strong dependency of electrical efficiency to thermal input and thermal oil supply temperature level on the primary side. The following simple equation could be determined.

$$P_{EL}(Q_{IN}; T_{IN}) = \frac{a \times Q_{IN} - b}{c + (d \times T_{IN})^E} \quad \text{Equation 1: Electric output, empirical fit}$$

With:

$$a = 0.127948 ; b = 144.514 ; c = 0.682714 ; d = 4.14555E^{-3} ; e = 217.046$$

Despite the larger amplitudes in the model the overall deviation in the daily yield is 0.016%. The average deviation per minute value is between +3.38% and -7.13%. During the displayed day one stop-start-procedure occurred (~12:00).

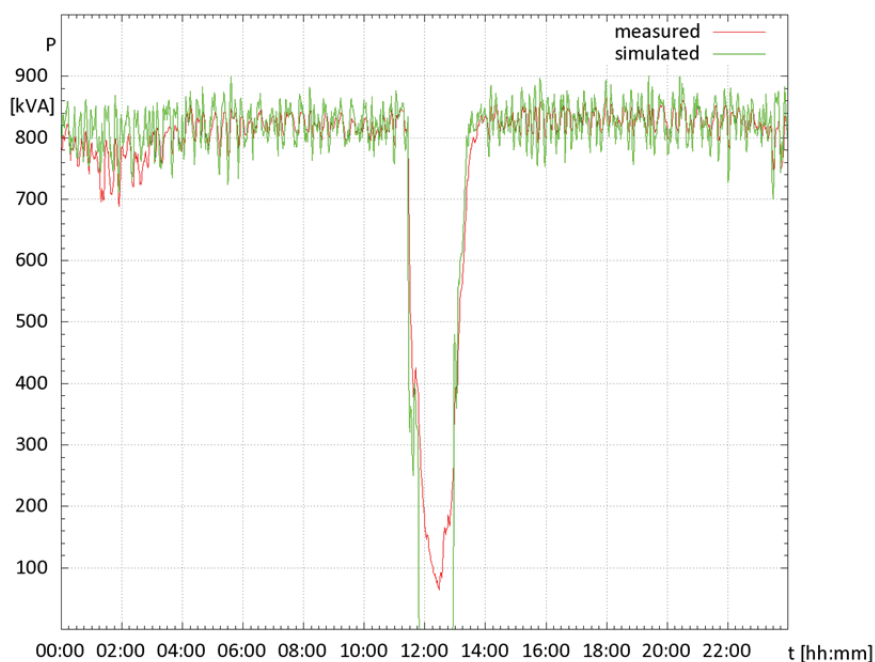

Figure 3: Empirical model of ORC, (1 day/01.04.2010)

The two major input parameters to determine the part-load efficiency are given, in order of importance, by the condenser mass flow and the district heating feeding temperature.

Evaporator

As the first component in the cycle the evaporator is analysed. From the computation of the thermodynamic properties of the fluid octamethyltrisiloxane (MDM) the evaporation pressure can be expected to follow this equation:

$$\frac{p}{p_c} = \exp\left(\frac{a\theta + b\theta^{1.5} + c\theta^{2.5} + d\theta^5}{T_R}\right) \text{ Equation 2: Wagner-Ambrose Equation for MDM [8]}$$

with

$$T_R = T/T_C \quad \text{and} \quad \theta = 1 - T/T_C$$

and

$$a = -8.6693 ; b = 2.2965 ; c = -4.4658 ; d = -8.4529$$

Plotting the measured pressure of MDM after the evaporator versus the thermal oil temperature the following characteristic can be observed:

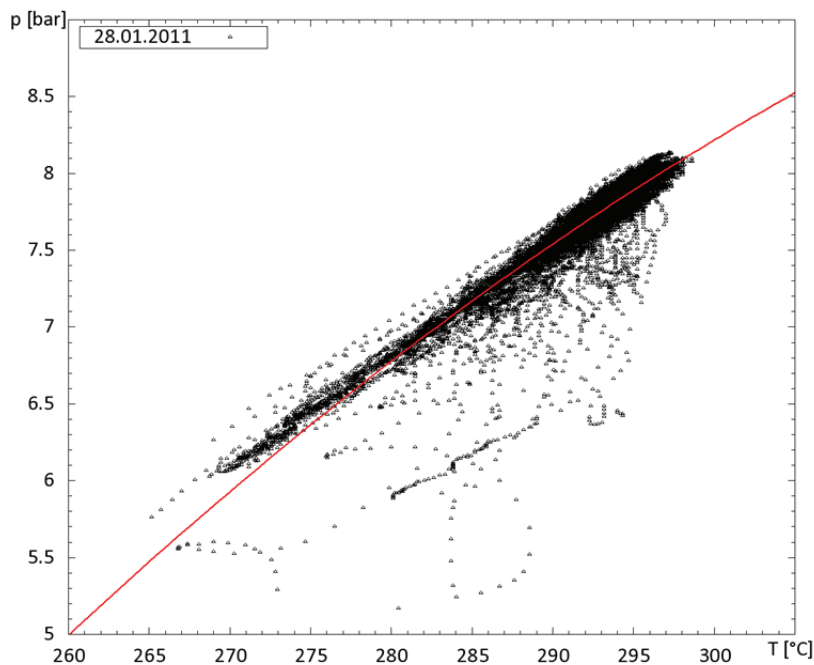

Figure 4: Evaporator behaviour

The expected exponential behaviour can be simplified in this short range by a 2nd degree polynomial. The single dots below the main cloud of values represents dynamic states, for instance at start-ups. The displayed values are obtained from a week's data between 01.01.2011 to 07.01.2011. Datasets in which the cycle was off the grid have been erased from the table.

Turbine and alternator

The turbine, a modified single stage type (C10S-II) by Tuthill Nadrowski, is expected to work with an isentropic efficiency of 0.78. The unit is connected to a gearbox (ratio 1:6). The nominal speed of the turbine is 500 RPM which is transformed to 3000 RPM for the synchronous alternator. The generator (DGI 450/2L WT) produced by Weier Electric with a rated power of 1500 kVA has the following characteristic:

Table 1: Load specifications of alternator [19]

load	[-]	25%	50%	75%	100%	125%
power input	[kVA]	399	779	1161	1546	1933
power output	[kVA]	375	750	1125	1500	1875
gross efficiency	[-]	94.1%	96.3%	96.9%	97.0%	97.0%
net efficiency*	[-]	93.1%	95.3%	95.9%	96.0%	96.0%

*including cooler

The table shows two efficiencies, with and without cooling. In this case the alternator is equipped with a cooler thus the net efficiency values have to be taken.

On base of the constant turbine efficiency given by the manufacturer and the alternator characteristic one should expect a degree of efficiency stable over a wide range.

To examine the turbine performance the thermodynamic states before and after the turbine have been measured (pressure, temperature). Furthermore the mass flow is taken after the feeding pump. Based on those values the turbine efficiency is calculated. To obtain the thermodynamic properties, formulations based on Peng-Robinson [4] and Colonna et al. [7]/[8] have been used.

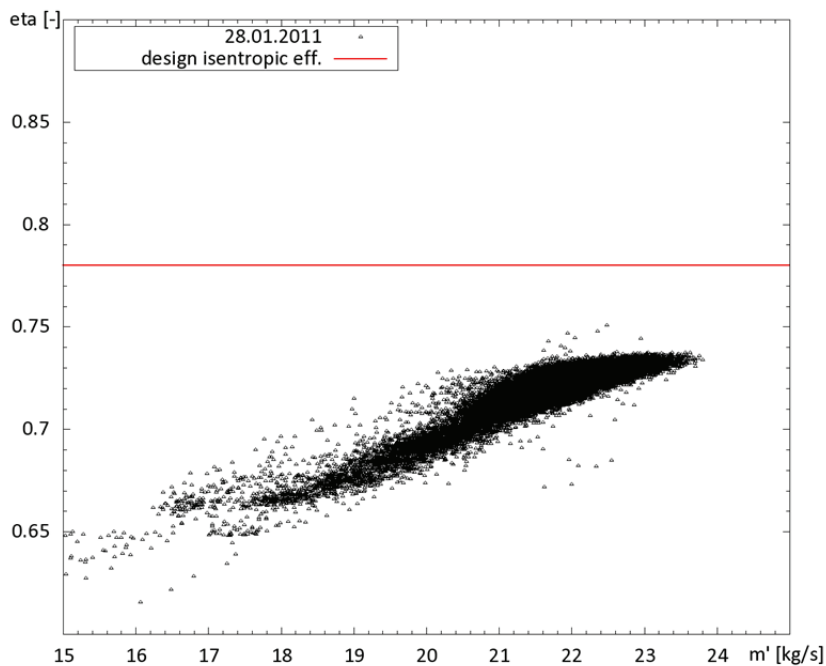

Figure 5: Isentropic efficiency of turbine versus fluid mass flow

Figure 5 shows a plot of turbine efficiencies of one week. The widely scattered points derive from opening and closing of the turbine control valve. These points are not representative for steady-state operation. The main cloud of points shows that the isentropic efficiency of the turbine is not design point. The turbine misses the design efficiency under full load conditions by 5 percentage points under the design specifications. The average value over this week is

71.08%. The shape of the cloud shows a weak performance in part-load, if the mass flow is reduced. This shows that this machine has deficiencies with partial admission.

Condenser

Figure 6 implies that there is no clear and strong dependency between the internal mass flow of the cycle (silicone oil) and the condensing pressure. Therefore the mass flow is unlikely influencing the condensing performance.

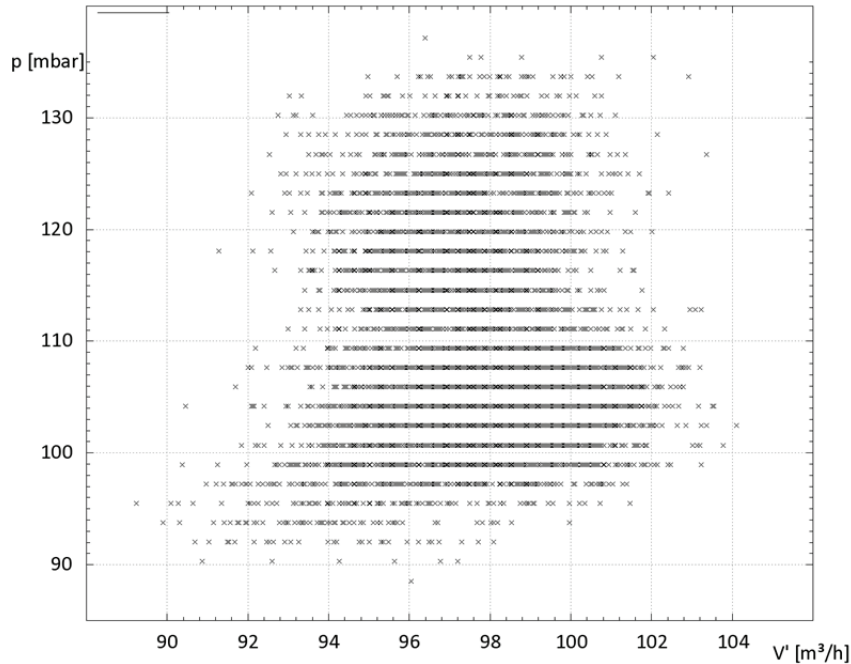

Figure 6: Condenser pressure vs. internal mass flow (10s/1 day/28.01.2011)

A rather stronger influence on the condenser pressure can be derived from Figure 7 where the pressure is plotted over the district heating feeding temperature (1 day/10s/28.01.2011). The network is designed for 15 K to 25 K temperature spread, for instance 75/60°C in summer and 85/60°C in winter. The values in the plot indicate that there is a linear dependence.

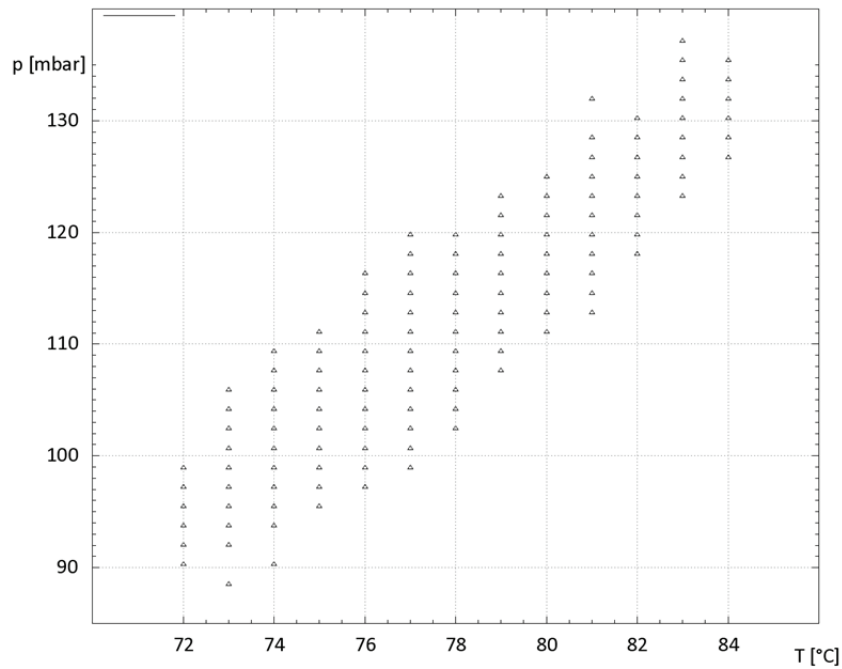

Figure 7: Condenser pressure vs. sink temperature

To find a second dependency in this case the MDM mass flow should be taken into account. As there are no direct measured values for the mass flow with the same time stamps the external temperature spread is taken instead to make an estimation of the mass flow.

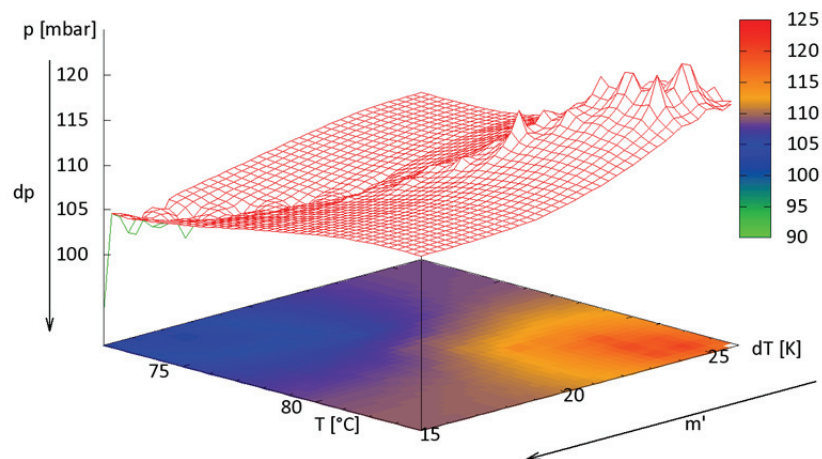

Figure 8: Condenser pressure vs. sink temperature and temperature spread

At high temperature differences the mass flow is expected to be lower and the turbine pressure slightly increases, as the heat transfer rates decrease.

Using the same values but plotting the electric gross efficiency instead the following characteristic can be shown:

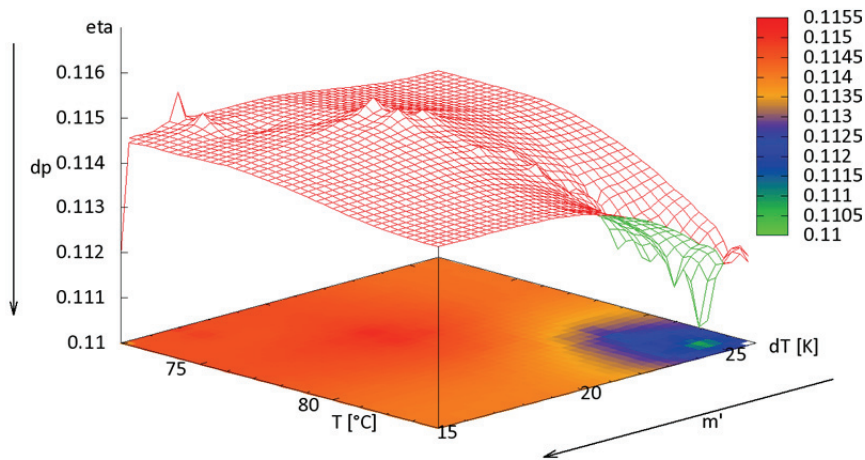

Figure 9: Electric efficiency vs. sink temperature and temperature spread

The cycle’s gross efficiency (measured) is plotted versus the feeding temperature and the temperature spread. The influence of the sink conditions between 72°C and 84°C and a temperature difference between 15 K and 25 K sum up to less than 5% efficiency change (a total change in efficiency of <0.5 percentage points).

Overall efficiency

The following figure shows hourly means calculated from minute values of 2008 (black) and values of 2010 (red). For safety reasons heat input and maximum pressure level have been limited in the control system in 2010. During the 2010 revision a great loss of working fluid had been discovered. The two main clouds represent summer (left) and winter (right) operation

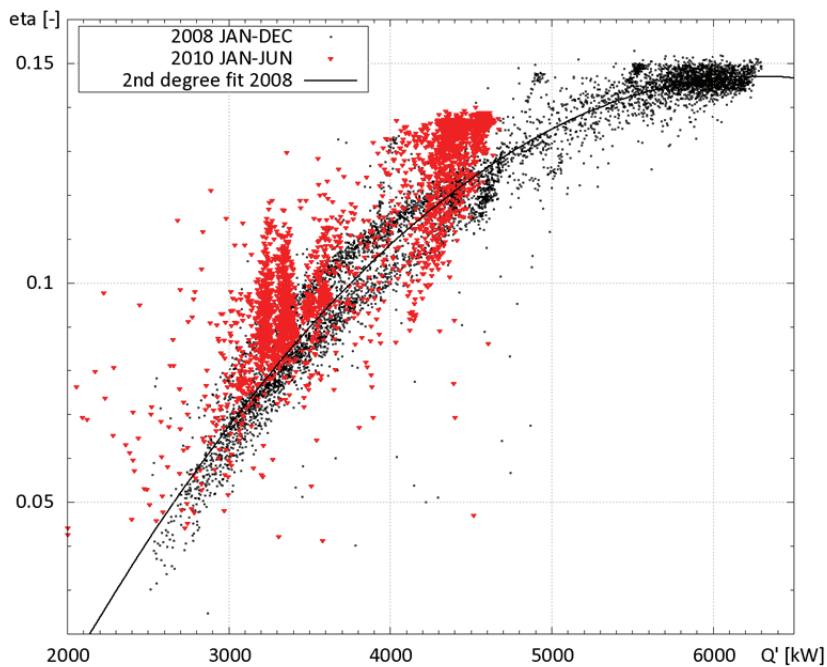

Figure 10: electric gross efficiency vs. thermal input (2008)

2nd European Conference on Polygeneration – 30th March -1st April 2011 – Tarragona, Spain
Maximum values of 14% to 15% of electric efficiency can be expected between 5.5 MW and 6.3 MW. The design efficiency of the cycle, predicted with 16.37% (at 5.8 MW) by the manufacturer could not be reached [4]. In the low operational range the point form two parallel clouds. These accumulations of states represent winter operation (upper) and summer operation (lower). In the summer mode even lower thermal inputs are recorded as the system is being run including the re-cooling unit which assures safe continuous operation.

Discussion

As the annual plot of efficiency values shows, heat guided ORCs do not necessarily have a large operational range on a comparably high efficiency level. Various parameters influence the achieved efficiency in a negative way. In theory it may well be that the thermal power input in the system does not affect the degree of efficiency noticeably. Lower loads on the biomass furnace lead to lower feeding temperatures in the thermal oil system. As the characteristic of the evaporator shows this has great influence on the upper system pressure and thus the pressure difference at the turbine.

Between the evaporator and the turbine inlet safety and control fittings, for instance cut-off valve, a control valve and a steam filter are situated. Depending on the mass flow in the system and the particles in the filter the pressure losses here are in a range between 0.3 bar and 0.7 bar. The condenser's behaviour usually is governed by the return temperature of the sink system. In the analysed plant the excess heat rejection unit is situated parallel in a loop with the condenser. The set point temperatures of the network feed is determined by ambient temperature. If this feed temperature level is exceeded the water is cooled down by the heat rejection unit and fed back to the return. The results show that the condensate pressure level is mainly a function of the feeding temperature and the mass flow on the secondary side. Using the vacuum pump to decrease the condenser pressure, besides the removal of gaseous agents, does not make sense in terms of economy. Assuming that the pump can achieve a maximum vacuum of 60 mbar and knowing that a variation between 90 mbar and 140 mbar leads to a rise of efficiency of less than 0.5%, a maximum further increase of 0.3% in electric efficiency is obtained if the pump is fully operating. For a generator with 500 kVA power and 1.1 kVA nominal power of the vacuum pump, the gain of 1.5 kVA stands versus a consumption of 1.1 kVA. Taking into account wear on the vacuum system and the loss of several litres of MDM a day the disadvantage of this strategy is quite obvious. Additionally the pressure difference has to be compensated by the feeding pump. Furthermore the experiences of the year 2010 clearly showed that the excessive usage of the vacuum pump leads to a low filling level of the cycle. The feeding pump is no longer capable of delivering the requested life steam pressure and volume as the hotwell runs dry. This causes unstable (dynamic) operation at a low pressure level.

The findings lead to several conclusions for economic operation of ORCs. The heat transfer characteristic of the condenser is mainly governed by the secondary sides temperatures and mass flows. Higher mass flows cause a lower temperature spread and increase turbulences; therefore the heat transfer coefficient rises. To find an overall optimum, the higher consumption of the network pumps has to be taken into consideration as well.

In addition the usage of synchronous alternators at a fixed speed leads to a low turbine admission at low silicone oil mass flows and causes stall. Thus lower enthalpy drops have to be expected. The comparably high isentropic efficiencies cannot be put into practice. This leads to part load conditions at the alternator at lower efficiency, which results in even lower yield. Load states with low mass flows of silicone oil should be avoided in terms of efficiency.

The results of the OR-cycle show clearly that the operation has not yet been optimal. The designed peak power could not be reached in daily operation. The upper pressure level of the cycle does not meet the specifications. The turbine characteristic appears to differ from the design data. Fast running small asynchronous engines can reach higher isentropic efficiencies in such cases.

Nomenclature

T	Temperature [K]
Q'	heat [MW _{th}], [kW _{th}]
MDM	Octamethyltrisiloxane
Q	MWh _{th} Megawatt hours thermal, [MWh _{el}] Megawatt hours electric
P	[kW _{el} / kVA] Kilowatts electric
MDM	Octamethyltrisiloxane, working fluid inside the Rankine-Cyle
T66	Therminol66 [®] thermal oil used in the transfer cycle of the power plant
SWE	Stadtwerke Esslingen GmbH&Co.KG, local supply company
EEE	Department of Electrical and Electronical Engineering
P-Bus	PROFIBUS, Profi Field Bus
TCP/IP	Transmission Control Protocol/Internet Protocol
OPC UA	OPC Unified Architecture
FTP	File transfer protocol
LHV	energy released in complete combustion under standard conditions
HHV	LHV + condensing heat of water vapour
NCV	see LHV
CSV	Character separated values

References

- [1] Duvia A., Technical and economic aspects of Biomass fuelled CHP plants based on ORC turbogenerators feeding existing district heating networks, 2009
- [2] Obernberger I., Hammerschmid A., Bini R., VDI-Bericht 1588, “Biomasse-Kraft-Wärme-Kopplungen auf Basis des ORC-Prozesses – EU-Thermie-Projekt Admont (A)”, 2001
- [3] Obernberger I., Thonhofer P., Reisenhofer E., Description and evaluation of the new 1,000 kW_{el} Organic Rankine Cycle process integrated in the biomass CHP plant in Lienz, Austria, (2002), pag. 17
- [4] Erhart T.G., “Optimierung biogen befeuerter ORC-Anlagen mit Hilfe von Computersimulationsmodellen”, Master Thesis, 2006, University of Applied Sciences Ulm
- [5] Nannan N.R., Advancements in nonclassical gas dynamics, University of Delft, 2009
- [6] Colonna P., Nannan N.R., Guardone A., Lemmon E.W., Multiparameter equations of state for selected siloxanes, Fluid Phase Equilibria 244, 2006
- [7] Colonna P., Guardone A., Nannan N.R., Siloxane: A new class of candidate Bethe-Zel'dovich-Thompson fluids, Physics of Fluids 19, 2007
- [8] Colonna P., Nannan N.R., Guardone A., Multiparameter equations of state for siloxanes, Fluid Phase Equilibria 263, pages 115-130, 2008
- [9] Flynn D., “Thermal Power Plant Simulation and Control”, IEE power Series, The Institution of Electrical Engineers, London, 2003

Reports available on the internet

- [10] Technical Report 07A03061e, “List of Recent Projects”, Turboden Srl, 31.05.2008, Brescia, Italy.
- [11] References of Turboden, Turboden s.r.l. Via Cernaia 10, 25124 Brescia – Italy
- [12] DIN EN 1434 Heat meters – Part 1: General requirements; German Version 2007

Internet references / misc:

- [13] Municipal Registry of the City of Ostfildern
- [14] <http://kamstrup.de/media/934/file.pdf> Maxical 401 heat meter specifications
- [15] <http://kamstrup.de/media/881/file.pdf> Maxical III heat meter specifications

- 2nd European Conference on Polygeneration – 30th March -1st April 2011 – Tarragona, Spain
- [16] http://www.iwu.de/fileadmin/user_upload/dateien/energie/werkzeuge/Gradtagszahlen_Deutschland.xls Degree days germany, Institut für Wohnen und Umwelt, 01.02.2011
- [17] Eureqa website: <http://ccsl.mae.cornell.edu/eureqa>
- [18] Softing OPC Toolkit: <http://www.softing.com/home/en/industrial-automation/products/opc/toolkits/overview.php>
- [19] Datasheet Weier Electric: GET_DGI 450 2L WT 1500kVA_Angeb LS 2006-02-23.doc
- [20] Datasheet Busch: Rotary claw vacuum pumps, Mink MM 1104 A V03, Busch

Acknowledgements

We would like to thank the local supplier SWE (Marc Hagenloch, Jochen Fink) for a very good collaboration. Special thanks to the City of Ostfildern (Frank Hettler). Merci beaucoup pour l'assistance a Éric Duminil de zafh.net. Many thanks to Andreas Trinkle for his great work on the OPC-system. Thanks to the eureqa team for a great piece of software.

POLYCITY is a project of the CONCERTO initiative, co-funded by the European Commission (TREN/05FP6EN/S07.43964/513481)